

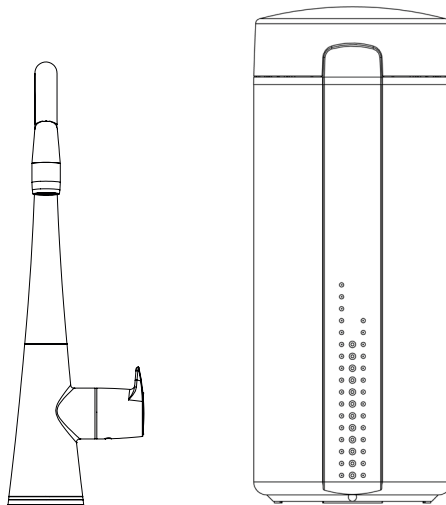

Product Instruction Manual
Zen Solo



SOLO3L, SOLO6L
Boiling Water Tap

Overview

Thank you for purchasing a Zen Solo 100°C instant boiling water tap. It replaces the need for a traditional kettle in the home, or counter/ wall mounted boiling water unit in the office.







The Zen Solo can be installed over a sink or with the stylish, tempered glass design Zen Font.















Key Features

- Energy efficient boiling water tank.
- Safety lock and cool touch spout.
- 360° swivel spout.
- Pattern recognition technology to learn and predict boiling water usage.
- Supplied with initial scale filter for the inlet to the boiling tank.
- Two temperature settings 100°C and 98°C.
- Designed and assembled in the UK.

Please fully read these instructions before commencing installation and follow to ensure that installation and operation are simple and safe.

1. Important Safety Points

-  Always switch off the mains electricity before commencing installation.
-  Only connect the unit to a single-phase supply as specified on the rating plate.
-  Ensure tank is full of water and tap flushed through before switching power on.
-  The supply cord cannot be replaced by the user. If the cord is damaged the appliance should be returned to the manufacturer or an authorised service agent for replacement.
-  The hoses and pipes supplying this heater must not come into contact with any fixed wiring or the supply cord.
-  Do not carry the appliance by the supply cord.

-  An RCD circuit breaker is strongly recommended.
-  This unit dispenses boiling water.
-  The boiling tank must be placed on a solid surface where it will not be knocked over causing damage to the water hoses or electrical connections.
-  The boiling tank must not be used in an area subject to flammable vapours such as paint, solvent or petrol.
-  This product is not suitable for outdoor use or in damp conditions.
-  Do not use in ambient temperatures exceeding 35°C.
-  Allow 20 mm space between the boiling tank and the walls for cooling air circulation.
-  The pressure relief valve supplied with the unit must be fitted.
-  The pressure relief valve must be tested regularly to remove scale deposits (see maintenance section).
-  Water may drip from the pressure relief valve; this must be piped to drain as per local relevant regulations.
-  This appliance can be used by children aged 12 years and above and persons with reduced physical, sensory or mental capabilities or lack of experience and knowledge if they have been given supervision or instruction concerning the use of the appliance in a safe way.
-  Children shall not play with the appliance.
-  Children shall not clean or maintain the appliance without supervision.
-  Before conducting any user maintenance, the product should be isolated from the electrical supply and then the boiling side of the tap opened until the water runs cold.
-  Do not modify or misuse the product in any way or serious injury could occur.

Box Contents

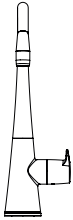

Zen Solo tap



Zen tank

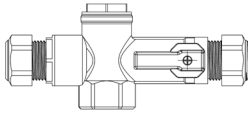

Manifold



Expansion vessel

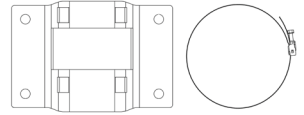

Expansion vessel fixing bracket and metal band

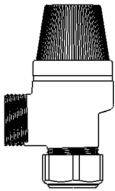

Pressure relief valve



Scale filter

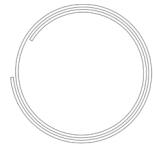

1.5 m x 3/8" tubing



Hose 'manifold to exp vessel'



Hose 'manifold to tank'



Hose 'tank to tap'

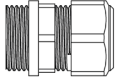

2 x 1/2" BSP to 15mm

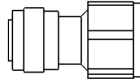

2 x 1/2" female to 3/8" PF

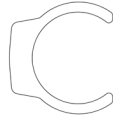

4 x Large locking collar



2 x Black rubber washer

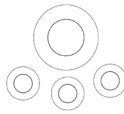

1 x Large and 3 x small white washer

1. Installation

Important Information



The tank must be sited vertically and on a flat level surface.



The supplied scale filter must be fitted and changed at least every 6 months, otherwise the lifespan of the product could be seriously reduced and the warranty may be void.



The supplied scale filter is suitable for up to 300 ppm. You may need to upgrade to a higher capacity filter in more aggressive water areas. **Note these are larger in size so ensure sufficient space is available.**



A pressure reducing valve is required if the mains pressure is above 0.42 MPa (4.2 bar).



The Zen Solo is factory set at 100°C. The temperature can be switched down to 98°C should this be desired. Please see Section 6 for further instructions.



White washers are to facilitate water connections on hoses labelled 'tank to tap' and 'manifold to tank'.



Black washers are to facilitate water connections on hose labelled 'manifold to exp vessel'.



Ensure that all hose connections are tightened using a suitable spanner.



Ensure that the tank, power socket, service valve and installation kit (manifold, relief valve and expansion vessel) are positioned to allow future maintenance.

Base of Solo Tap

Important
Grey area represents expansion zone. It is imperative that no fittings, other than those specified, are installed within the 'expansion zone'. Ensure the correct washers are used for each hose connection. Ensure all push fit connections are secured with a suitable locking collar.

- A Large white washer
- B Small white washer
- C Black washer

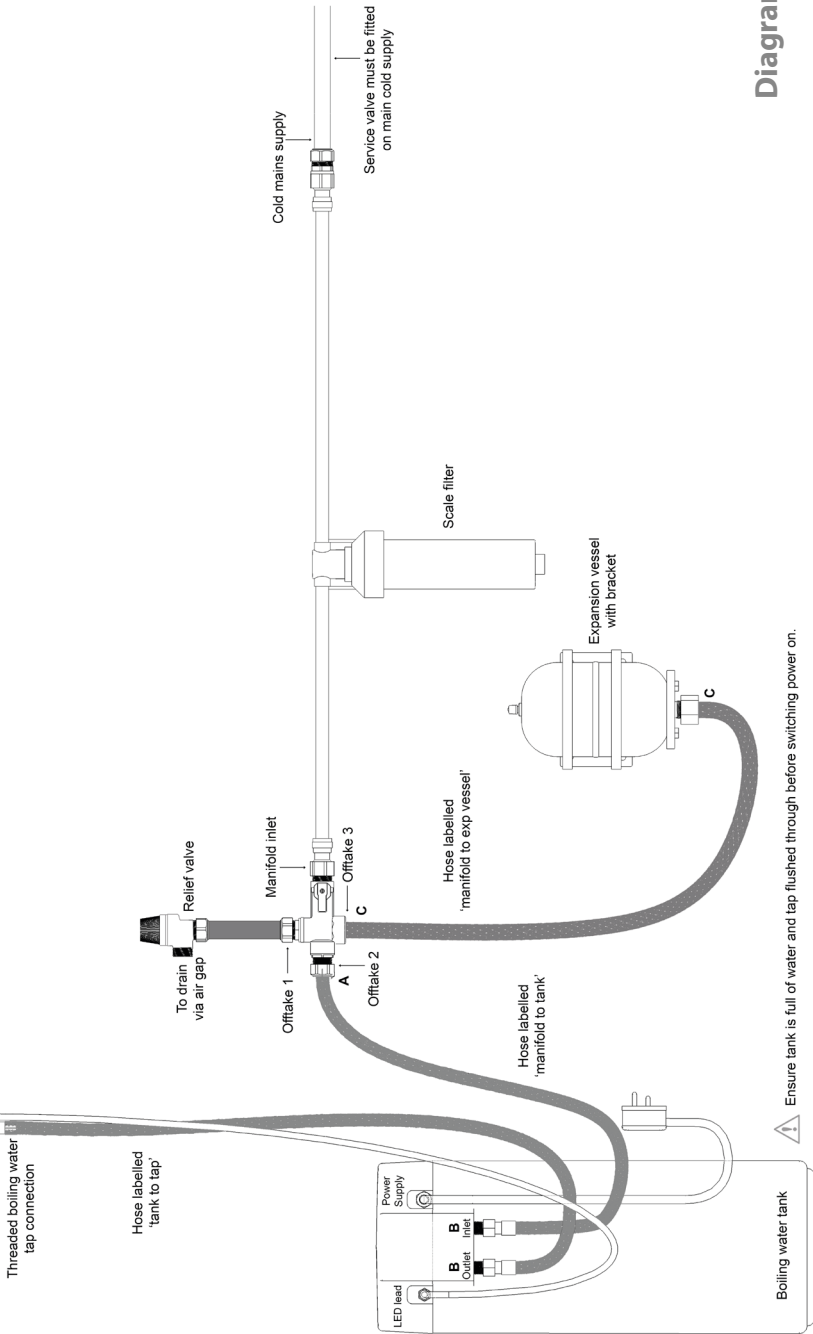

⚠ Ensure tank is full of water and tap flushed through before switching power on.

Diagram 1

Step 1 - Prepare and Site the Tap

- Choose a suitable location to mount the tap, this may be an existing hole in your sink or countertop.
- If a new hole is required check that the reach of the spout will be appropriate for your sink before drilling the tap hole in the sink or worktop. The required hole diameter is 32 mm - fits in a standard sink.
- If installing in a Zen Font with Drain use the template supplied with the Zen Font to establish tap hole position.
- The tap can be installed onto sink/countertop up to 50 mm thick.
- Place tap into hole, ensure the black o-ring is above the worktop. See Diagram 2.
- Place the steel washer onto the threaded section of the tap under worktop/ sink.
- Lastly screw the brass locking nut onto the threaded section. This will secure the tap in position.

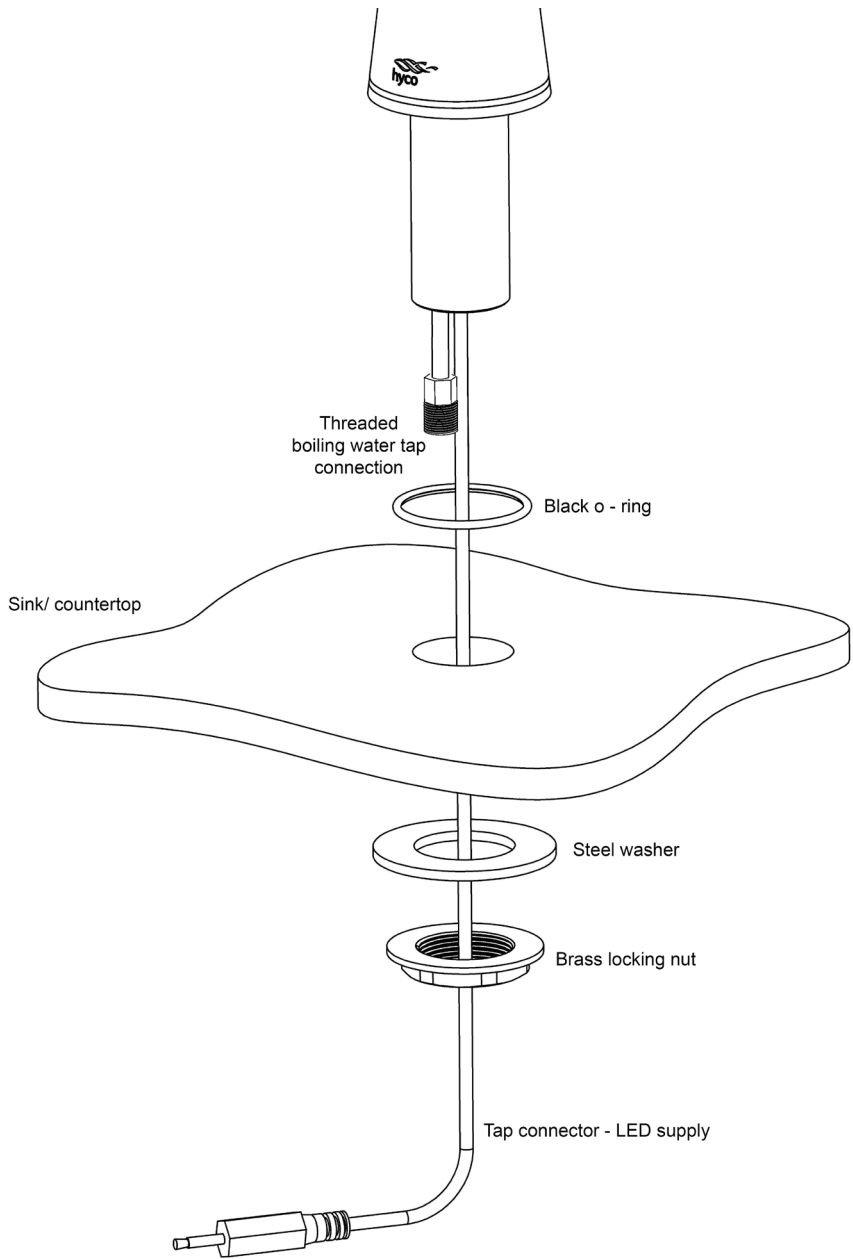

Diagram 2

Step 2 - Prepare Manifold Connections



It is essential that no fittings, other than those specified in the instructions, are installed within the 'expansion zone'. This is everything beyond the check valve, located within the manifold. See Diagram 3.

- Use Diagram 1 to establish suitable locations for each component which forms part of the full installation.
- Note the boiling tank must be located as close to the tap as practicable as it is not possible to extend hoses provided.
- Attach ½" M BSP to 15 mm compression fitting to offtake 1 of the manifold and tighten with spanner, see Diagram 3. Connect desired length of copper pipe then connect to pressure relief valve.
- Pressure relief valve is a safety device which must be fitted and piped to drain via air gap before commissioning.
- From offtake 3 of the manifold attach hose labelled 'manifold to exp vessel' using 1 black washer.

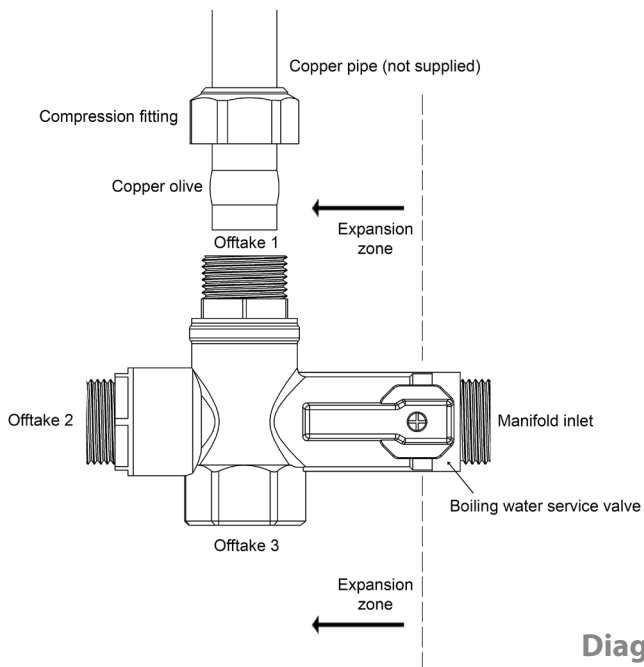

Diagram 3

Step 3 - Mount Manifold and Connect Expansion Vessel



Orientation of the manifold is optional, but the direction of flow must follow the arrow on the manifold. The red handle is a service valve (boiling water isolation lever) for future maintenance.

- Position the boiling tank vertically beneath the tap so that the flexible hoses and tap connector (black lead, 3.5 mm jack) can comfortably reach the tap and water supply.
- Choose desired location for manifold and mount using pipe clips (not supplied).
- Select a suitable location for the expansion vessel, consider the reach of hose labelled 'manifold to exp vessel' as well as the need to keep the vessel itself in an upright orientation (fitting at the bottom).
- Mount the expansion vessel bracket to the required surface using screw pack.
- Attach the other end of hose labelled 'manifold to exp vessel' to expansion vessel using 1 black washer.
- Secure expansion vessel in place against bracket using metal band.

Step 4 - Connect Boiling Tank and Solo Tap

- Remove red caps from inlet and outlet connections at the back of the boiling tank.
- From offtake 2 of the manifold attach hose labelled 'manifold to tank' using 1 large white washer. Connect remaining end to tank inlet using 1 small white washer.
- Connect hose labelled 'tank to tap' to the tank outlet using 1 small white washer. Connect other end to threaded boiling tap connection using 1 small white washer.
- Connect the black lead tap connector which is attached to the tap to the back of the tank. This is a 3.5 mm jack which connects just above the tank inlet and outlet.

Step 5 - Connect Mains Cold and Scale Filter



The supplied scale filter is suitable for up to 300 ppm. You may need to upgrade to a higher capacity filter in more aggressive water areas. **Note these are larger in size so ensure sufficient space is available.**

- Isolate mains supply and make a connection using the 1/2" BSP to 15 mm brass fitting supplied. We recommend fitting a service valve (not supplied) close by to aid any future maintenance.
- Connect 1/2" female to 3/8" PF (push fit) connector to the brass fitting.
- **Ensure all tubing is pushed fully into PF connectors and that locking collars are used to prevent inadvertent removal.**

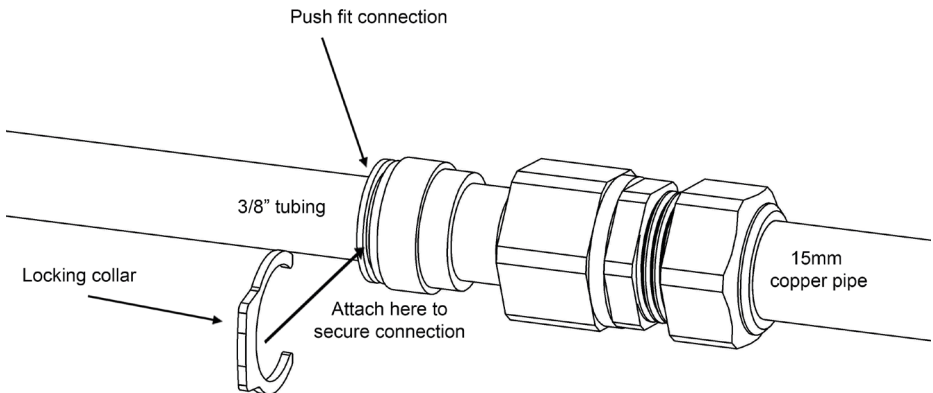

- Select a suitable location for the scale filter housing ensuring easy access for future maintenance. The arrow represents the water flow direction and must be followed.
- Depending on installation you may need to remove the filter head from bracket and rotate 180° to ensure flow arrow is followed.
- To do so first remove filter cartridge. Now grip bracket in one hand and the top t-section with the other, turn 90° anticlockwise to release.
- Rotate 180° and reinsert t-section, turning 90° in whichever direction is required depending on installation, to secure.
- Do not locate the filter above an electrical socket or other electrical device.

- Secure the bracket to the wall using the fixings supplied. Replace the scale filter cartridge.
- Use a suitable length of 3/8" tubing (cut using sharp knife, ensuring a clean straight cut) to connect from mains supply to scale filter head inlet, ensuring water flow arrow is followed.
- Use a suitable length of 3/8" tubing to connect from the scale filter head outlet, ensuring water flow arrow is followed, to manifold inlet using 1/2" female to 3/8" PF connector.

3. Commission and Check Water Connections



Before plugging the tank into the power socket, the system must be full of water and tested for leaks.

- Open all water valves to allow water to flow to the boiling water tank.
- Pull the boiling tap handle out to release the safety lock (see Section 5) and turn away from you to fill the tank, this will take approx 1 minute. When the tank is full, water will flow from the spout.
- Check water flows smoothly from the tap to ensure all air has been purged from the system, this could take up to 1 minute.
- Test the pressure relief valve by twisting the red cap until water flows from the valve.
- If the pressure relief valve is discharging whilst the heater is turned off this is a sign that the incoming pressure exceeds the 6 bar rating of the pressure relief valve. A pressure reducing valve is required (not supplied).
- When the air is purged, the tap is closed and the system is fully pressurised, inspect all connections for leaks.
- Flush any filters through ensuring the water runs clear.
- Ensure there are no obstructions in the expansion zone between the manifold and the tank.

4. Electrical Connection



Before plugging the tank into the power socket, the system must be full of water and tested for leaks.

- Ensure that the installation area is dry.
- The boiling water tank is supplied with a pre-wired (1m) BS plug.
- Insert the plug into a suitable socket and turn the power socket on at the switch.
- The boiling tank will take approx 13 minutes to heat up from cold, depending on incoming water temperature.
- Check for signs of discharge from the pressure relief valve.

IMPORTANT

- **Following the first boiling cycle it is imperative to check all connections on the boiling side and tighten all flexible hoses to and from the tank as these can loosen on the first boiling cycle.**

5. Operation



This appliance can be used by children aged 12 plus and persons with reduced physical, sensory or mental capabilities or lack of experience and knowledge if they have been given supervision or instruction concerning the use of the appliance in a safe way.

Smart Technology

- The boiling water tank has smart technology algorithms that learn and predict usage: on when you need it, off when you don't.
- The status ring on the base of the tap will light up red or green depending on the temperature of the water in the tank.
- The red status ring indicates the water is heating. The green status ring indicates the water is up to temperature and ready for use.
- When the heater is in a predicted non-use period (sleep mode) the status ring will be green and fade on and off slowly. To exit this mode, open the boiling side of the tap and allow water to flow until the status ring flashes green. The heater will then return to boiling shortly after.
- If the status light begins flashing red this indicates a fault has been detected. The unit should be isolated from the power supply and the water supply shut off before contacting Hyco for further advice.

Status Ring Summary

Red	Water is heating
Green	Water is up to temperature - ready to use
Fading in/ out green	Predicted non - use period (sleep mode)
Flashing red	Fault detected

Operating the Boiling Tap

- The boiling tap handle has a safety lock mechanism. To release the safety lock, pull the handle away from the tap body. To dispense boiling water rotate forwards.

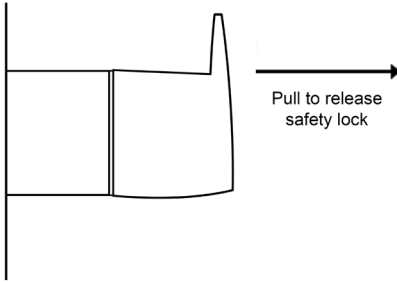

Operating the Tank

- Once the boiling tank is installed following the correct installation instructions there should be no further operation required.
- In the event you wish to switch between 100°C and 98°C please see Section 6. The factory setting is 100°C.



Please note the Zen tank is a storage type heater - it cannot deliver a continuous flow of hot water.

6. Change Temperature Setting and Thermal Cut-out Reset



The appliance must first be isolated from the mains power supply by unplugging but is not necessary to isolate the water supply.



Open the boiling side of the tap until water runs cold.



The Zen Life is factory set at 100°C. The temperature of dispensed boiling water can be changed on the tank PCB. Switch between 'LO' 98°C or 'HI' 100°C.

- See Diagram 8 and 9 overleaf.
- For the 3L and 6L models unscrew the 2 crosshead screws that retain the boiling tank lid.
- Lift the lid slightly from the back before removing by sliding it forward to free it from the retaining lug at the front.
- For the 6L model unscrew the 2 crosshead screws that retain the back section and remove.
- To change the temperature locate the temperature setting switch; slide to HI for 100°C / LO for 98°C setting as appropriate.
- To reset the thermal cut-out locate and press the reset button. For the 3L model this is on the PC board. For the 6L model it is on the top of the boiling tank.
- For the 6L model replace the back section and replace two retaining screws.
- For the 3L and 6L model replace the lid by first lining up the lug at the front before gently angling the back into place. Replace the two retaining screws.
- When the lid is secured in place re-connect the electrical supply.

3L Model PC Board

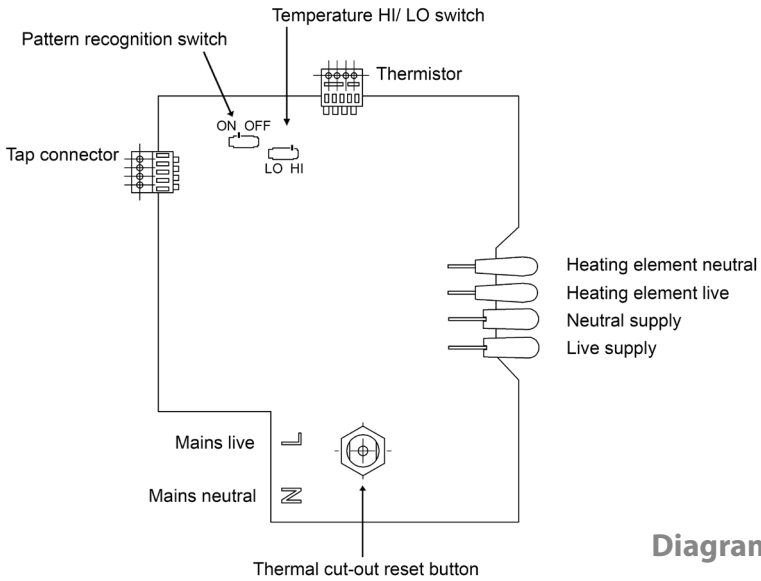

Diagram 8

6L Model PC Board

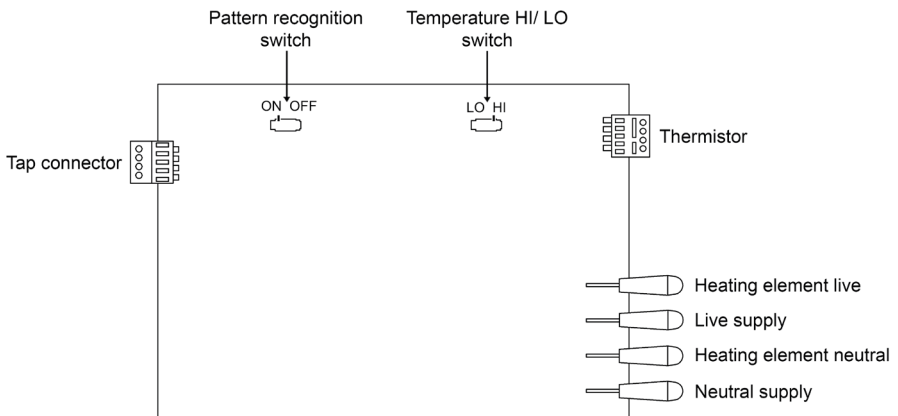

Diagram 9

7. Maintenance



Before conducting any user maintenance, the appliance must first be isolated from the electrical supply by removing the appliance plug from the electrical outlet. Run the boiling tap until it is dispensing cold water.



Cleaning and user maintenance should not be carried out by children without supervision.



If the unit is unused for extended periods of time, it should be unplugged and drained.



If there is any risk of the installation environment dropping below freezing the appliance should be switched off and drained.

- Replace the scale filter cartridge at least every 6 months or when rated capacity is reached, whichever comes first. This is imperative to protect against scale build up. Failure to do so may void the warranty.
- Regularly inspect the appliance for any signs of water leaks or damage. If a leak or damage is discovered, discontinue use, isolate the water supply and drain down immediately. Contact Hyco.
- The relief valve must be regularly tested. To do this twist the red cap until water flows from the valve. If water does not flow it must be replaced.
- The tap and water tank can be cleaned with a lint free damp cloth. Do not use any abrasive or caustic cleaning products, this will damage the surface of the appliance.

8. Replace Filter Cartridge



Replace the scale filter cartridge every 6 months or when rated capacity is reached, whichever comes first. This is imperative to protect against scale build up. Failure to change the scale filter may void the warranty.



Before commencing place a bowl or cloth under the filter to catch any small escape of water.

- To change the filter grip the filter head, rotate the existing cartridge 90° anticlockwise and pull out.
- Insert the new cartridge into the filter head and rotate 90° clockwise.
- Flush the filter through ensuring the water runs clear.

9. Draining



Do not connect to electricity supply without re-filling the tank, checking for leaks and purging any air out of the system.

- Unplug the unit from the electricity mains.
- Run the boiling tap until it is dispensing cold water.
- Unplug the black lead tap connector (3.5 mm jack) from the back of the heater.
- Turn off water supply. Disconnect the water supply to the tank and tap. Lift the tank to the sink, turn upside down and drain all the water from the tank.
- When re-installing follow the original installation instructions.

10. Descaling the Tank

The tank should be descaled at least annually and more frequently in aggressive water areas. A service cartridge can be used. These are available from Hyco, please contact our service department for further information.

11. Specification

Supply	230V ~ 50Hz
Power 3/ 6L model	1.60/ 2.84 kW
Tank capacity 3/ 6L model	3/ 6 litres
Max water pressure	0.42 MPa (4.2 bar)*
Min water pressure	0.1MPa (1 bar)
Max tank pressure	0.6 MPa (6 bar)
Ambient operating temperature	5 – 35°C
Approvals	CE

* If pressure is above 0.42 MPa (4.2 bar) a pressure reducing valve is required.

12. Troubleshooting

Problem	Likely Fault(s)	Solution
Water and steam spitting from the tap	This is normal but temperature can be adjusted if desired. Water temperature is set to 100°C.	Turn temperature down to 98°C on PC board. See Section 6
Tank not heating and no LED lights	Thermal cut out has tripped	Reset using cut out button. See Section 6
Tank not heating and red light flashing	Software error	Contact Hyco
Water dripping from the tap	Tap fault	Contact Hyco
Low flow from the tap	Scale filter needs changing	Replace scale filter cartridge. See Section 8
Low flow from the tap	Scale build up in tank	Descale tank. See section 10
Low flow from the tap	Aerator needs cleaning	Unscrew, remove and clean aerator
Dispensed water is too hot	Water temperature is set to 100°C	Turn temperature down to 98°C on PC board. See Section 6

13. Dimensions

	Height (mm)	Width (mm)	Depth (mm)
Zen Solo Tap	288	152	49
Tank 3L	459	182	221
Tank 6L	460	230	270

14. Guarantee

This product is covered by a standard parts or replacement warranty for a period of 2 years from the date of purchase.

If there is a manufacturing defect within the warranty period we will send spare parts, repair and return the unit or, at our discretion, supply a replacement product. Incorrect installation, frost damage, the consequences of limescale deposits or failure to follow correct operating and maintenance instructions are excluded. Consequential costs such as labour charges or damage to fittings and surroundings are expressly excluded.

15. Contact Us

If you experience a problem with this product you should first contact our service department on 01924 225 200 before taking any further action. Experience has shown that issues can often be resolved without the need to return or uninstall the product.



INFORMATION FOR CORRECT DISPOSAL OF THE PRODUCT IN ACCORDANCE WITH THE EUROPEAN DIRECTIVE 2012/19/EU.

At the end of its working life this equipment must not be disposed of as household waste. It must be taken to a local authority waste collection centre or to a dealer providing this service. Disposing of electrical and electronic equipment separately enables its components to be recovered and recycled to obtain significant savings in energy and resources. In order to underline the duty to dispose of this equipment separately, the product is marked with a crossed out dustbin.

Hyco Manufacturing Ltd
Normandy Court
Express Way
Castleford, WF10 5NR

hyco.co.uk



100724

T 01924 225 200
F 01924 225 210
E sales@hyco.co.uk

